

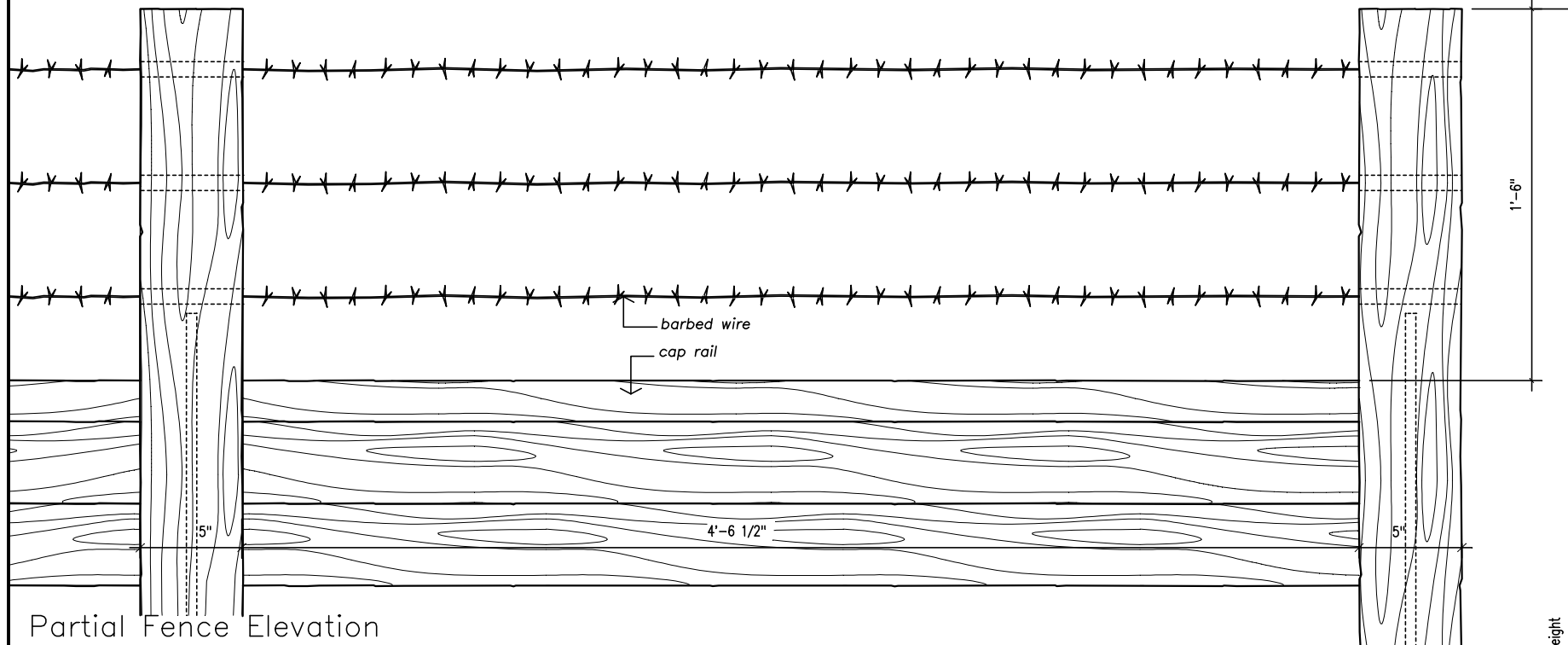

# FENCECRETE AMERICA, INC.

manufacturers of precast concrete fencing and masonry wall systems  
 15089 tradesmen drive san antonio, texas 78249 210-492-7911 800-229-7811 www.fencecrete.com



Partial Fence Elevation

scale: 1-1/2" = 1'-0"



Wood Style Concrete Fence  
with Security Wire

footing: 18" diameter, 24" deep (min.)  
3000 p.s.i. concrete, varies  
according to local soil conditions

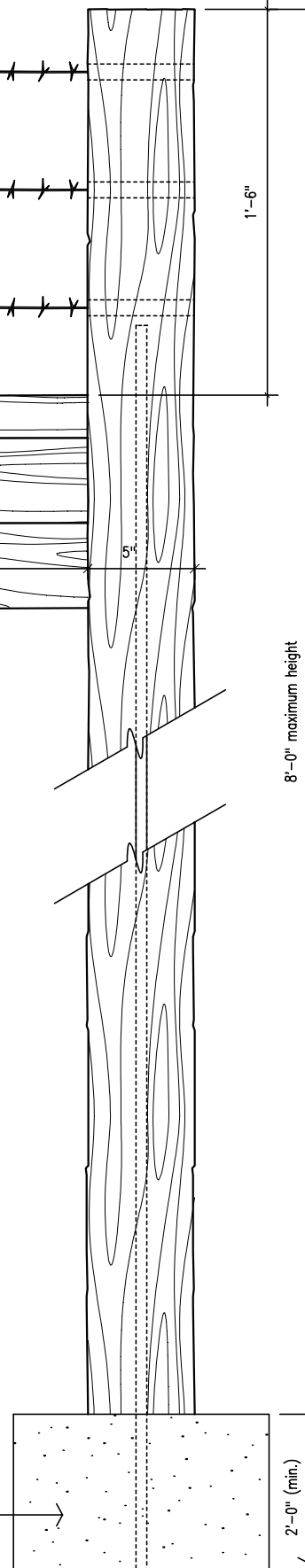

Elevation of Post Top

scale: 3" = 1'-0"

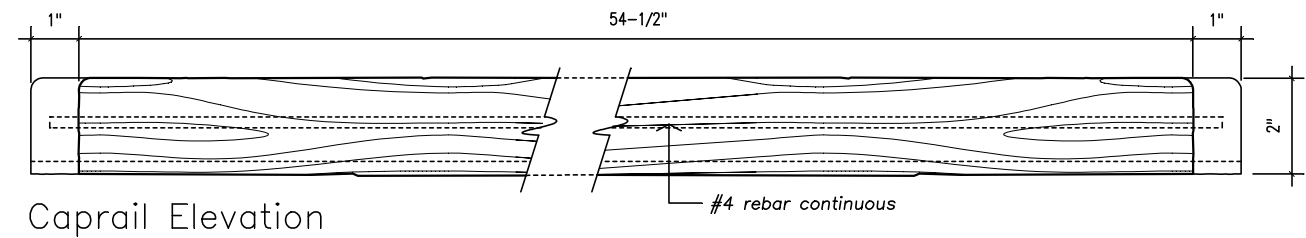

Caprail Elevation

scale: 3" = 1'-0"

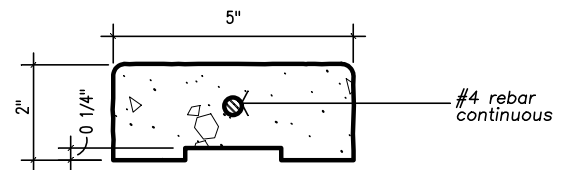
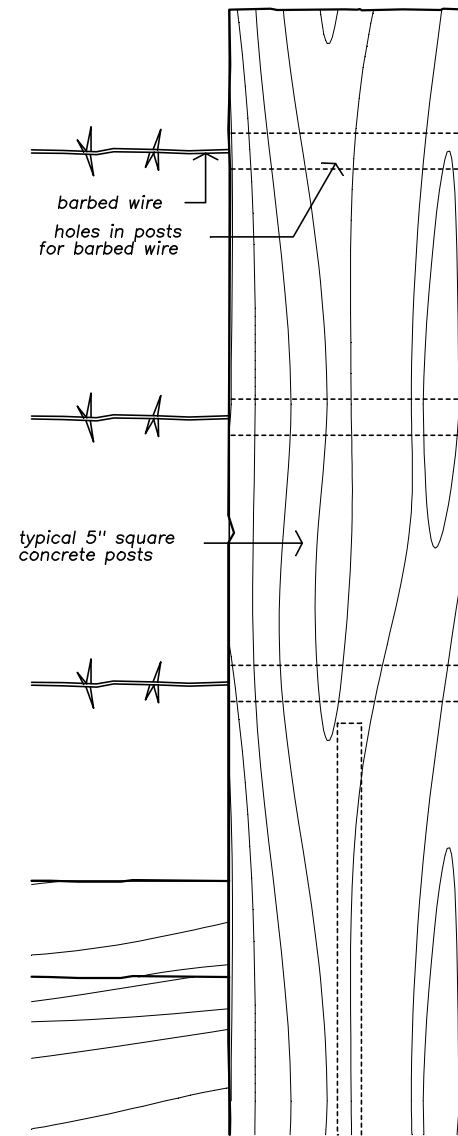

Caprail Section

scale: 3" = 1'-0"

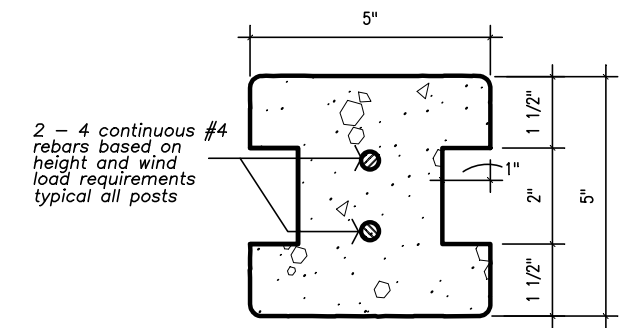

Running Post Section

scale: 3" = 1'-0"

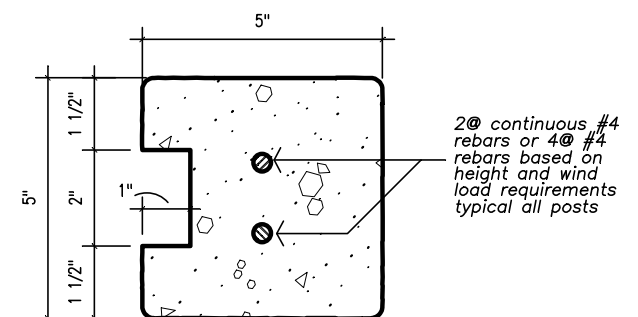

Stop Post Section

scale: 3" = 1'-0"

notes:

1. The column height can be from 0 to a maximum of 10'-0". Additional heights are available upon special order.
2. All concrete shall be 5000 p.s.i.
3. All reinforcement shall be A.S.T.M. 615 grade 60. Special reinforcement is available upon special order.
4. Footing - 2 feet deep (min.) footing standard per column, 12" - 18" diameter. Depth and diameter can vary per local soil conditions.
5. Color: Tan / Brown. Any other specific color will be produced upon special order.
6. Texture: All exposed sides have heavy wood-grained texture.
7. Gates: Shall have additional steel supports adjacent to concrete columns.
8. All steel reinforcement is prewelded with steel spacers so as to allow for maximum concrete coverage.
9. A special silicone sealant is used to lock the caprail in place. This sealant requires special tools for removal.

We reserve the right to alter the design or specifications without incurring any obligation, all rights reserved.  
Fencecrete America, Inc.