

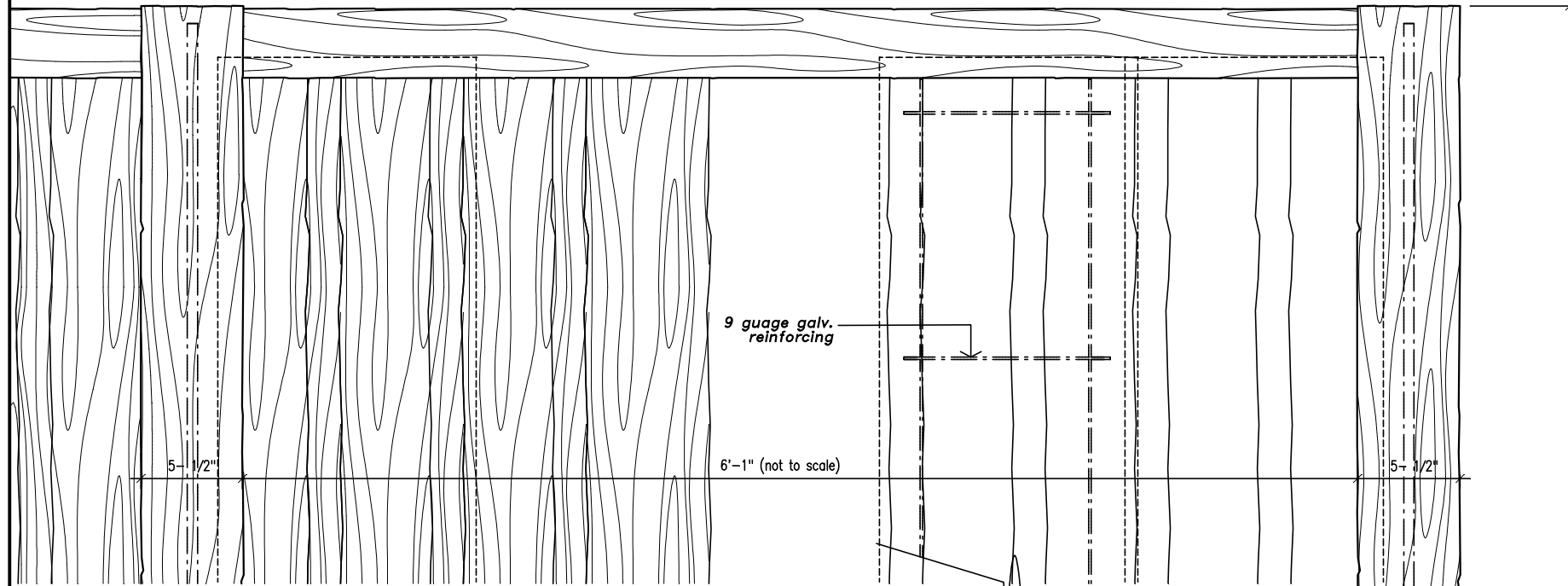

# FENCECRETE AMERICA, INC.

manufacturers of precast concrete fencing and masonry wall systems  
 15089 tradesmen drive san antonio, texas 78249 210-492-7911 800-229-7811 www.fencecrete.com



Partial Fence Elevation

scale: 1-1/2" = 1'-0"

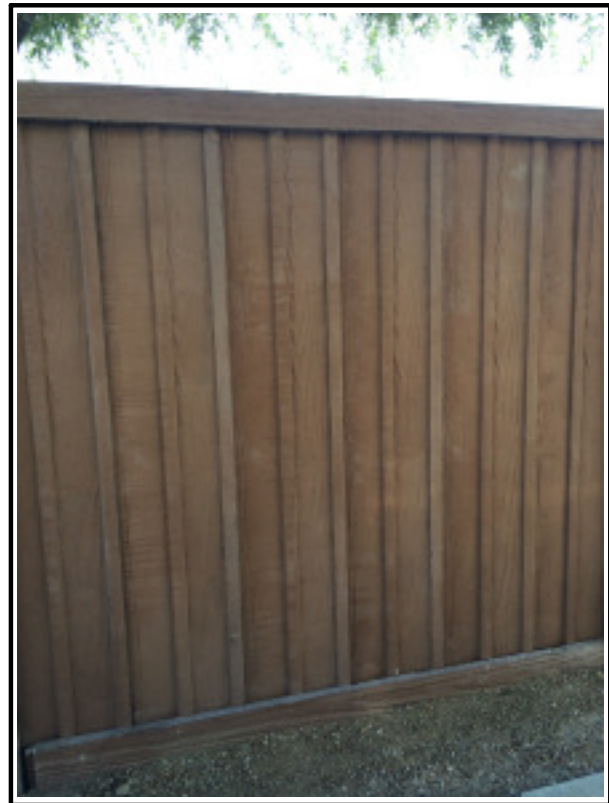

## Vertical Board and Batten Style Concrete Fence

footing: 18" diameter, 24" deep (min.)  
 3000 p.s.i. concrete, varies according to local soil conditions

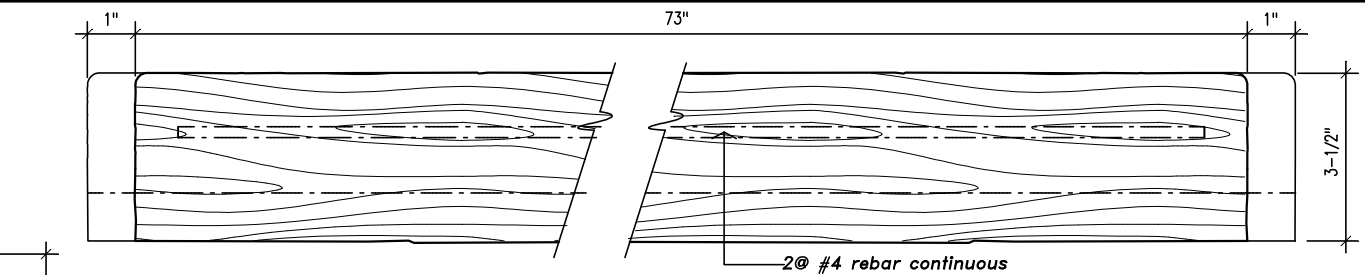

### Caprail Elevation

front view

scale: 3" = 1'-0"

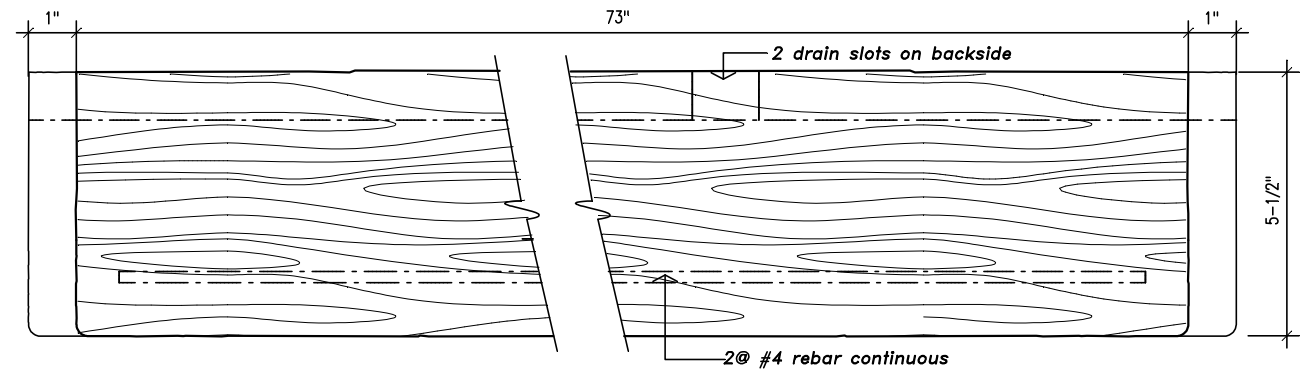

### Bottom Beam Elevation

front view

scale: 3" = 1'-0"

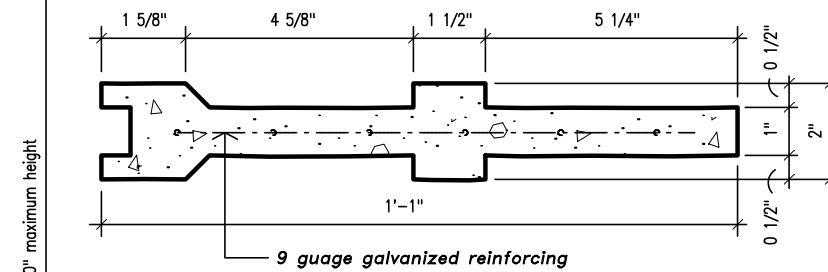

### Typical Panel Section

scale: 3" = 1'-0"

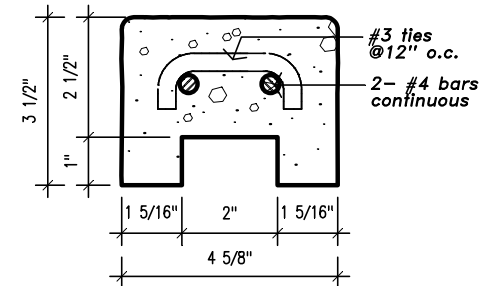

### Caprail Section

scale: 3" = 1'-0"

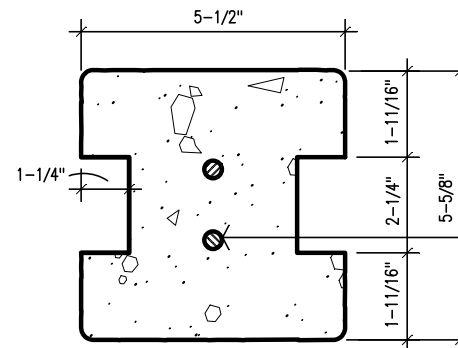

### Running Post Section

scale: 3" = 1'-0"

NOTE: Details of additional fence post conditions are similar to those shown on Wood Style Conc. Fence Detail sheet

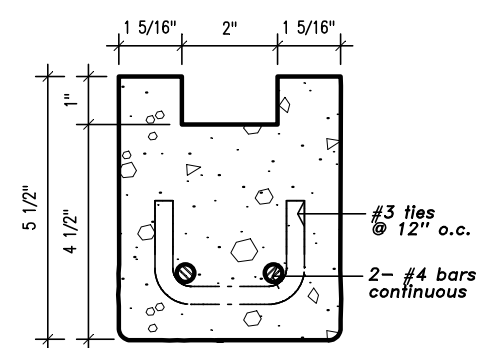

### Bottom Beam Section

scale: 3" = 1'-0"

#### notes:

1. Fence height is 6'-0".
2. All concrete shall be 5000 p.s.i.
3. All reinforcement shall be A.S.T.M. 615 grade 60. Special reinforcement is available upon special order.
4. Footing - 2 feet deep (min.) footing standard per column, 12" - 18" diameter. Depth and diameter can vary per local soil conditions.
5. Texture: All exposed sides have heavy wood-grained texture.
6. Gates: Shall have additional steel supports adjacent to concrete columns.
7. All steel reinforcement is prewelded with steel spacers so as to allow for maximum concrete coverage.
8. A special silicone sealant is used to lock the caprail in place. This sealant requires special tools for removal.

We reserve the right to alter the design or specifications without incurring any obligation, all rights reserved.  
 Fencecrete America, Inc.